

FAMILY OF MICROPOWER RAIL-TO-RAIL OUTPUT OPERATIONAL AMPLIFIERS

FEATURES

- **BiMOS Rail-to-Rail Output**
- **Input Bias Current . . . 1 pA**
- **High Wide Bandwidth . . . 160 kHz**
- **High Slew Rate . . . 0.1 V/μs**
- **Supply Current . . . 7 μA (per channel)**
- **Input Noise Voltage . . . 89 nV/√Hz**
- **Supply Voltage Range . . . 2.7 V to 16 V**
- **Specified Temperature Range**
 - –40°C to 125°C . . . Industrial Grade
 - 0°C to 70°C . . . Commercial Grade
- **Ultra-Small Packaging**
 - 5 Pin SOT-23 (TLV27L1)

APPLICATIONS

- **Portable Medical**
- **Power Monitoring**
- **Low Power Security Detection Systems**
- **Smoke Detectors**

DESCRIPTION

The TLV27Lx single supply operational amplifiers provide rail-to-rail output capability. The TLV27Lx takes the minimum operating supply voltage down to 2.7 V over the extended industrial temperature range, while adding the rail-to-rail output swing feature. The TLV27Lx also provides 160-kHz bandwidth from only 7 μA. The maximum recommended supply voltage is 16 V, which allows the devices to be operated from (±8-V supplies down to ±1.35 V) two rechargeable cells.

The rail-to-rail outputs make the TLV27Lx good upgrades for the TLC27Lx family—offering more bandwidth at a lower quiescent current. The TLV27Lx offset voltage is equal to that of the TLC27LxA variant. Their cost effectiveness makes them a good alternative to the TLC/V225x, where offset and noise are not of premium importance.

The TLV27L1/2 are available in the commercial temperature range to enable easy migration from the equivalent TLC27Lx. The TLV27L1 is not available with the power saving/performance boosting programmable pin 8.

The TLV27L1 is available in the small SOT-23 package—something the TLC27(L)1 was not—enabling performance boosting in a smaller package. The TLV27L2 is available in the 3mm x 5mm MSOP, providing PCB area savings over the 8-pin SOIC and 8-pin TSSOP.

SELECTION GUIDE

DEVICE	V _S [V]	I _Q /ch [μA]	V _{ICR} [V]	V _{IO} [mV]	I _{IB} [pA]	GBW [MHz]	SLEW RATE [V/μs]	V _n , 1 kHz [nV/√Hz]
TLV27Lx	2.7 to 16	11	–0.2 to V _S +1.2	5	60	0.18	0.06	89
TLV238x	2.7 to 16	10	–0.2 to V _S –0.2	4.5	60	0.18	0.06	90
TLC27Lx	4 to 16	17	–0.2 to V _S –1.5	10/5/2	60	0.085	0.03	68
OPAx349	1.8 to 5.5	2	–0.2 to V _S +0.2	10	10	0.070	0.02	300
OPAx347	2.3 to 5.5	34	–0.2 to V _S +0.2	6	10	0.35	0.01	60
TLC225x	2.7 to 16	62.5	0 to V _S –1.5	1.5/0.85	60	0.200	0.02	19

NOTE: All dc specs are maximums while ac specs are typicals.



Please be aware that an important notice concerning availability, standard warranty, and use in critical applications of Texas Instruments semiconductor products and disclaimers thereto appears at the end of this data sheet.

PRODUCTION DATA information is current as of publication date. Products conform to specifications per the terms of Texas Instruments standard warranty. Production processing does not necessarily include testing of all parameters.

PACKAGE/ORDERING INFORMATION

PRODUCT	PACKAGE	PACKAGE CODE	SYMBOL	SPECIFIED TEMPERATURE RANGE	ORDER NUMBER	TRANSPORT MEDIA
TLV27L1CD	SOIC-8	D	27V1C	0°C to 70°C	TLV27L1CD	Tube
					TLV27L1CDR	Tape and Reel
TLV27L1CDBV	SOT-23	DBV	VBIC		TLV27L1CDBVR	Tape and Reel
					TLV27L1CDBVT	
TLV27L1ID	SOIC-8	D	27V1I	-40°C to 125°C	TLV27L1ID	Tube
					TLV27L1IDR	Tape and Reel
TLV27L1IDBV	SOT-23	DBV	VBII		TLV27L1IDBVR	Tape and Reel
					TLV27L1IDBVT	
TLV27L2CD	SOIC-8	D	27V2C	0°C to 70°C	TLV27L2CD	Tube
					TLV27L2CDR	Tape and Reel
TLV27L2ID	SOIC-8	D	27V2I	-40°C to 125°C	TLV27L2ID	Tube
					TLV27L2IDR	Tape and Reel

absolute maximum ratings over operating free-air temperature (unless otherwise noted)†

Supply voltage, V_S	16.5 V
Input voltage, V_I (see Note 1)	V_S
Output current, I_O	100 mA
Differential input voltage, V_{ID}	V_S
Continuous total power dissipation	See Dissipation Rating Table
Maximum junction temperature, T_J	150°C
Operating free-air temperature range, T_A : C suffix	0°C to 70°C
	I suffix
Storage temperature range, T_{stg}	-65°C to 125°C
Lead temperature 1,6 mm (1/16 inch) from case for 10 seconds	300°C

† Stresses beyond those listed under “absolute maximum ratings” may cause permanent damage to the device. These are stress ratings only, and functional operation of the device at these or any other conditions beyond those indicated under “recommended operating conditions” is not implied. Exposure to absolute-maximum-rated conditions for extended periods may affect device reliability.

NOTE 1: Relative to GND pin.

DISSIPATION RATING TABLE

PACKAGE	θ_{JC} (°C/W)	θ_{JA} (°C/W)	$T_A \leq 25^\circ\text{C}$ POWER RATING	$T_A = 85^\circ\text{C}$ POWER RATING
D (8)	38.3	176	710 mW	370 mW
DBV (5)	55	324.1	385 mW	201 mW
DBV (6)	55	294.3	425 mW	221 mW

recommended operating conditions

		MIN	MAX	UNIT
Supply voltage, (V_S)	Dual supply	±1.35	±8	V
	Single supply	2.7	16	
Input common-mode voltage range		-0.2	$V_S - 1.2$	V
Operating free-air temperature, T_A	C-suffix	0	70	°C
	I-suffix	-40	125	

electrical characteristics at recommended operating conditions, $V_S = 2.7\text{ V}$, 5 V , and 10 V (unless otherwise noted)

dc performance

PARAMETER		TEST CONDITIONS	T_A †	MIN	TYP	MAX	UNIT
V_{IO}	Input offset voltage	$V_{IC} = V_S/2$, $R_L = 100\text{ k}\Omega$, $V_O = V_S/2$, $R_S = 50\ \Omega$	25°C	0.5		5	mV
			Full range			7	
α_{VIO}	Offset voltage drift		25°C	1.1			$\mu\text{V}/^\circ\text{C}$
CMRR	Common-mode rejection ratio	$V_{IC} = 0\text{ V to }V_S - 1.2\text{ V}$, $R_S = 50\ \Omega$	25°C	71	86		dB
			Full range	70			
A_{VD}	Large-signal differential voltage amplification	$V_{O(PP)} = V_S/2$, $R_L = 100\text{ k}\Omega$	25°C	80	100		dB
			25°C	77	82		

† Full range is -40°C to 125°C for I suffix.

input characteristics

PARAMETER		TEST CONDITIONS	T_A	MIN	TYP	MAX	UNIT
I_{IO}	Input offset current	$V_{IC} = V_S/2$, $R_L = 100\text{ k}\Omega$, $V_O = V_S/2$, $R_S = 50\ \Omega$	$\leq 25^\circ\text{C}$		1	60	pA
			$\leq 70^\circ\text{C}$			100	
			$\leq 125^\circ\text{C}$			1000	
I_{IB}	Input bias current	$V_{IC} = V_S/2$, $R_L = 100\text{ k}\Omega$, $V_O = V_S/2$, $R_S = 50\ \Omega$	$\leq 25^\circ\text{C}$		1	60	pA
			$\leq 70^\circ\text{C}$			200	
			$\leq 125^\circ\text{C}$			1000	
$r_{i(d)}$	Differential input resistance		25°C	1000			G Ω
C_{IC}	Common-mode input capacitance	$f = 1\text{ kHz}$	25°C	8			pF

power supply

PARAMETER		TEST CONDITIONS	T_A †	MIN	TYP	MAX	UNIT
I_Q	Quiescent current (per channel)	$V_O = V_S/2$	25°C		7	11	μA
			Full range			16	
PSRR	Power supply rejection ratio ($\Delta V_S/\Delta V_{IO}$)	$V_S = 2.7\text{ V to }16\text{ V}$, $V_{IC} = V_S/2\text{ V}$, No load,	25°C	74	82		dB
			Full range	70			

† Full range is -40°C to 125°C for I suffix.

electrical characteristics at recommended operating conditions, $V_S = 2.7\text{ V}$, 5 V , and $\pm 5\text{ V}$ (unless otherwise noted) (continued)

output characteristics

PARAMETER		TEST CONDITIONS	T_A^\dagger	MIN	TYP	MAX	UNIT
V_O	Output voltage swing from rail	$V_{IC} = V_S/2$, $I_{OL} = 100\ \mu\text{A}$	$V_S = 2.7\text{ V}$	25°C	200	160	V
				Full range	220		
			$V_S = 5\text{ V}$	25°C	120	85	
				Full range	200		
		$V_S = \pm 5\text{ V}$	25°C	120	50		
			Full range	150			
		$V_{IC} = V_S/2$, $I_{OL} = 500\ \mu\text{A}$	$V_S = 5\text{ V}$	25°C	800	420	
				Full range	900		
$V_S = \pm 5\text{ V}$	25°C		400	200			
	Full range		500				
I_O	Output current	$V_O = 0.5\text{ V}$ from rail	$V_S = 2.7\text{ V}$	25°C	400		μA

† Full range is -40°C to 125°C for I suffix.

dynamic performance

PARAMETER		TEST CONDITIONS	T_A	MIN	TYP	MAX	UNIT
GBP	Gain bandwidth product	$R_L = 100\text{ k}\Omega$, $C_L = 10\text{ pF}$, $f = 1\text{ kHz}$	25°C		160		kHz
SR	Slew rate at unity gain	$V_{O(pp)} = 1\text{ V}$, $R_L = 100\text{ k}\Omega$, $C_L = 50\text{ pF}$	25°C		0.06		V/ μs
			-40°C		0.05		
			125°C		0.8		
ϕ_M	Phase margin	$R_L = 100\text{ k}\Omega$, $C_L = 50\text{ pF}$	25°C		62		°
t_s	Settling time (0.1%)	$V_{(STEP)pp} = 1\text{ V}$, $A_V = -1$, $C_L = 50\text{ pF}$, $R_L = 100\text{ k}\Omega$	Rise	25°C		62	μs
			Fall			44	

noise/distortion performance

PARAMETER		TEST CONDITIONS	T_A	MIN	TYP	MAX	UNIT
V_n	Equivalent input noise voltage	$f = 1\text{ kHz}$	25°C		89		$\text{nV}/\sqrt{\text{Hz}}$
I_n	Equivalent input noise current	$f = 1\text{ kHz}$	25°C		0.6		$\text{fA}/\sqrt{\text{Hz}}$

TYPICAL CHARACTERISTICS

Table of Graphs

			FIGURE	
V_{IO}	Input offset voltage	vs Common-mode input voltage	1, 2, 3	
I_{IB}/I_{IO}	Input bias and offset current	vs Free-air temperature	4	
V_{OH}	High-level output voltage	vs High-level output current	5, 7, 9	
V_{OL}	Low-level output voltage	vs Low-level output current	6, 8, 10	
I_Q	Quiescent current	vs Supply voltage	11	
		vs Free-air temperature	12	
Supply voltage and supply current ramp up			13	
A_{VD}	Differential voltage gain and phase shift	vs Frequency	14	
GBP	Gain-bandwidth product	vs Free-air temperature	15	
ϕ_m	Phase margin	vs Load capacitance	16	
CMRR	Common-mode rejection ratio	vs Frequency	17	
PSRR	Power supply rejection ratio	vs Frequency	18	
		Input referred noise voltage	vs Frequency	19
SR	Slew rate	vs Free-air temperature	20	
$V_{O(PP)}$	Peak-to-peak output voltage	vs Frequency	21	
		Inverting small-signal response	22	
		Inverting large-signal response	23	
Crosstalk			vs Frequency	24

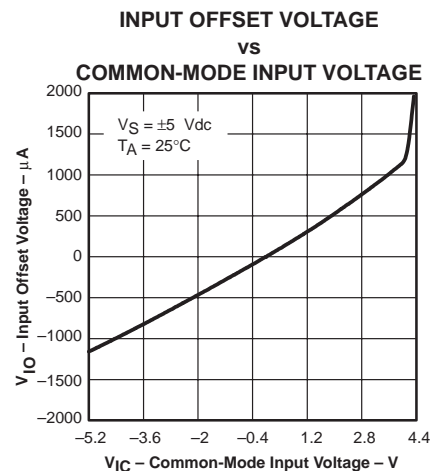
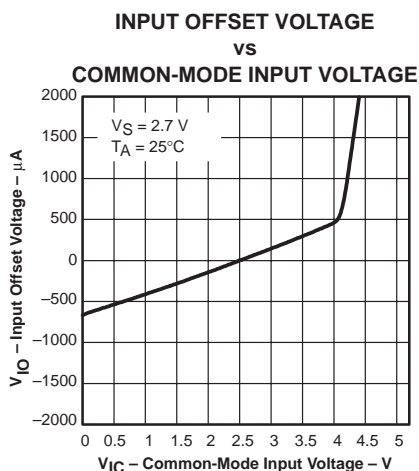
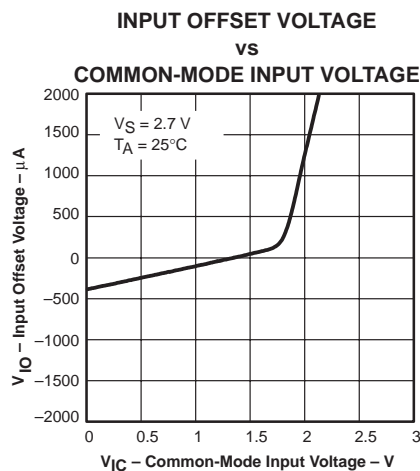

TYPICAL CHARACTERISTICS

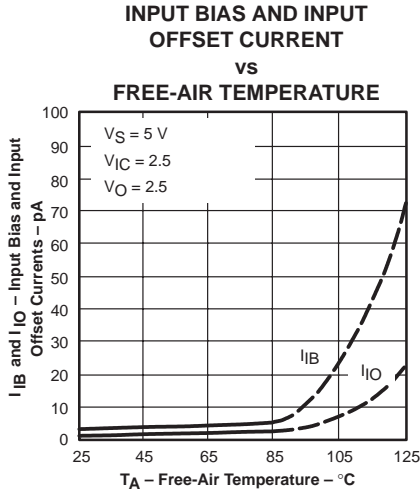

Figure 4

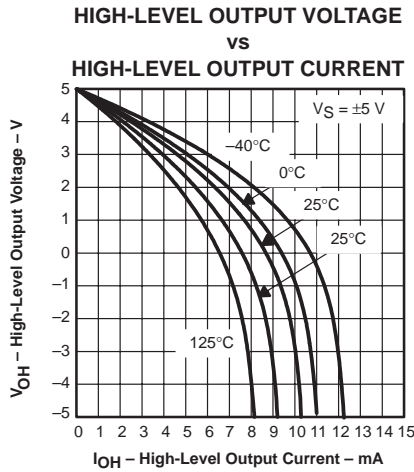

Figure 5

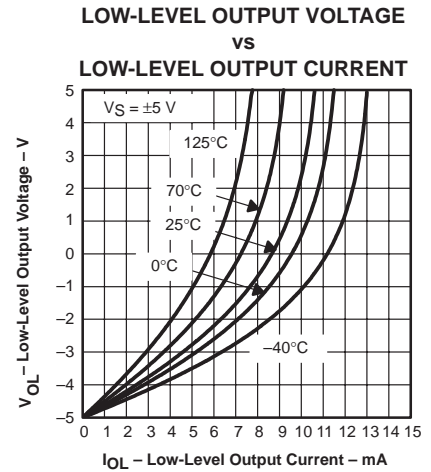

Figure 6

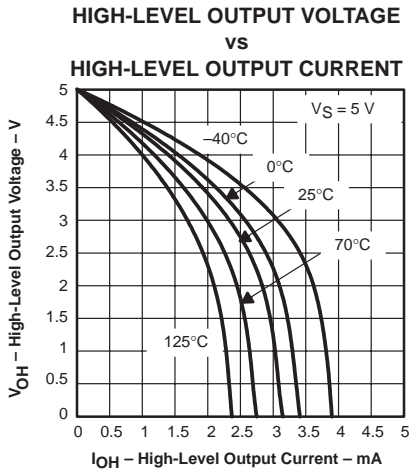

Figure 7

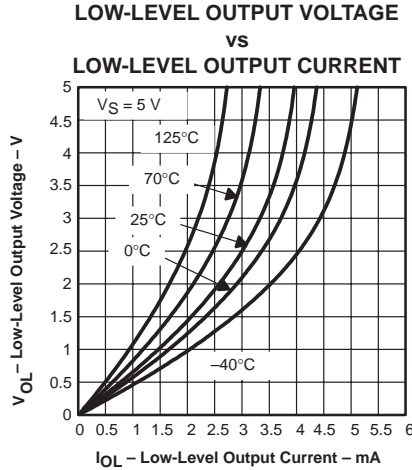

Figure 8

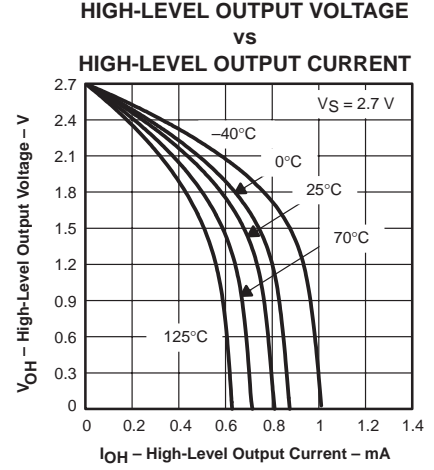

Figure 9

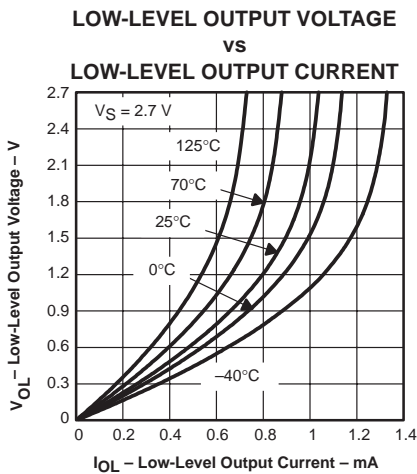

Figure 10

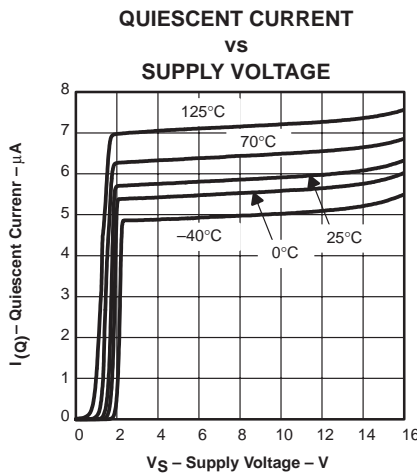

Figure 11

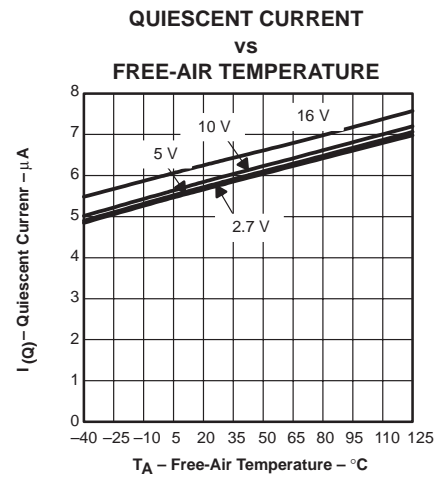

Figure 12

TYPICAL CHARACTERISTICS

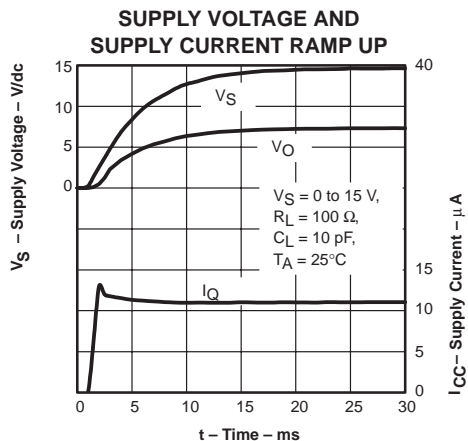

Figure 13

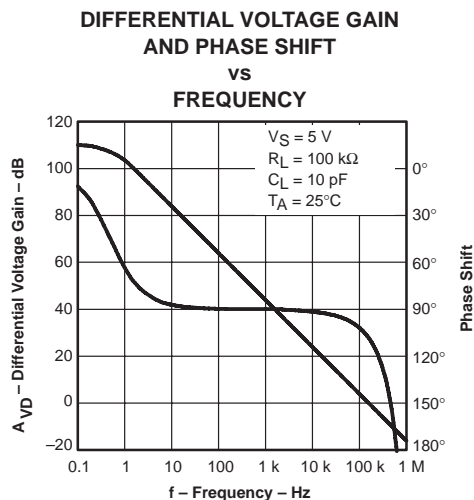

Figure 14

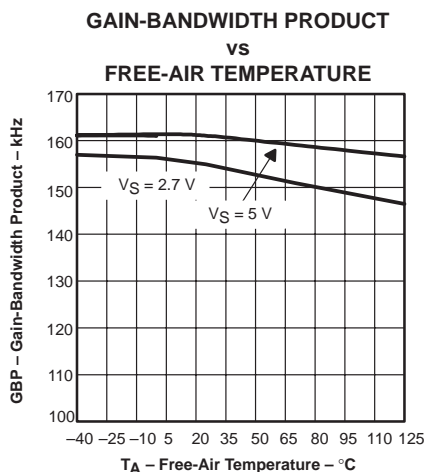

Figure 15

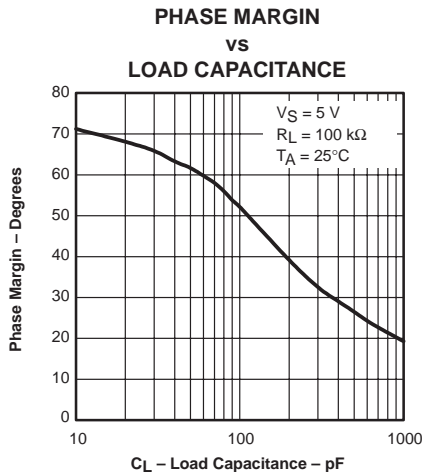

Figure 16

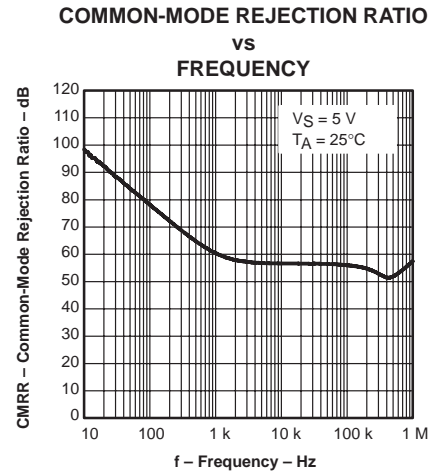

Figure 17

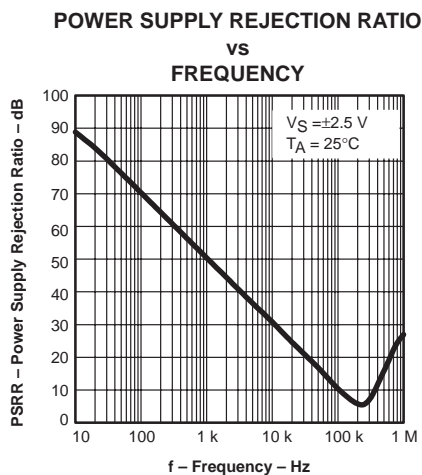

Figure 18

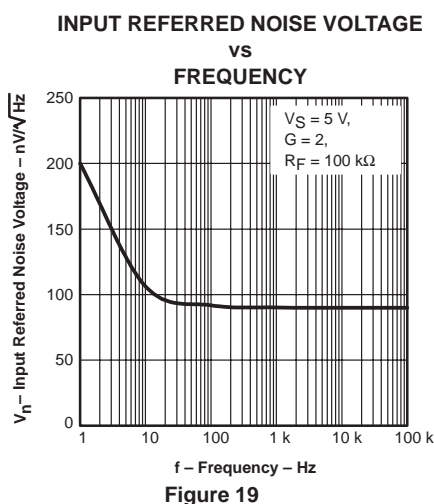

Figure 19

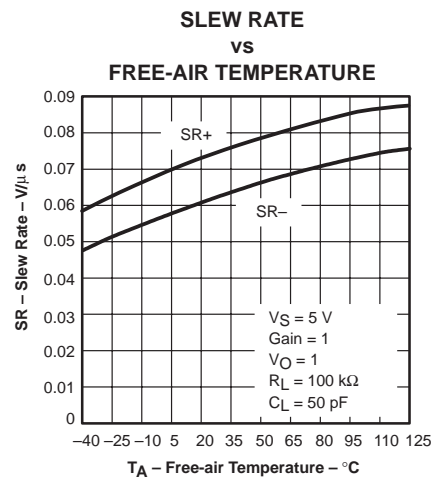
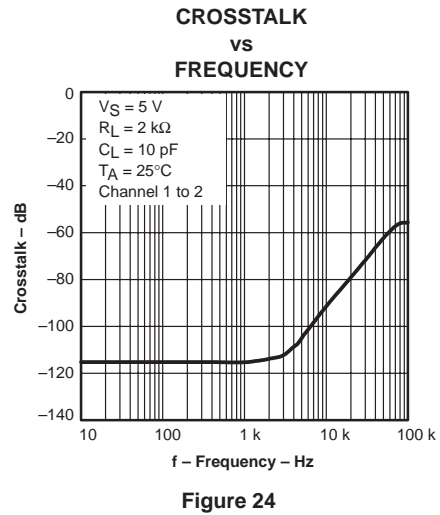
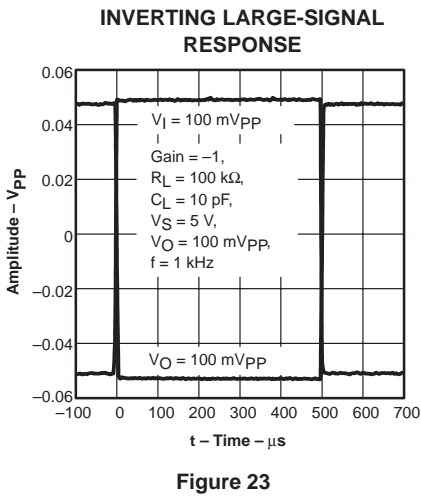
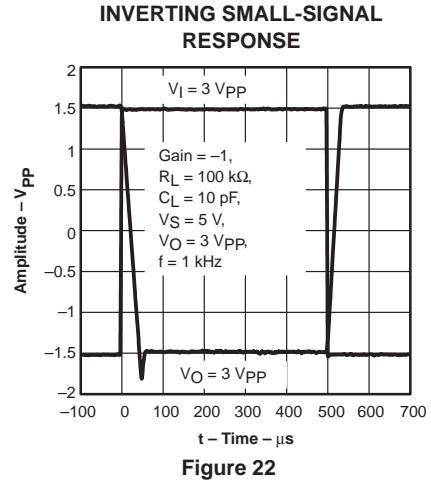
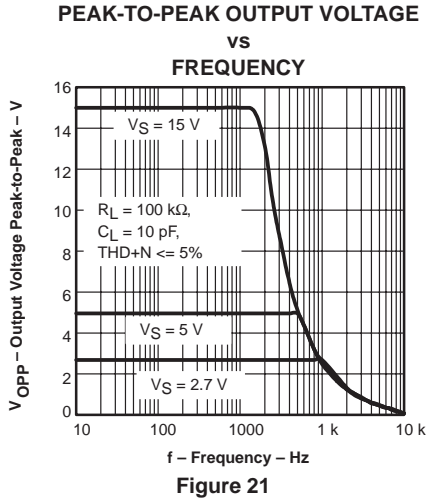

Figure 20

TYPICAL CHARACTERISTICS



APPLICATION INFORMATION

offset voltage

The output offset voltage (V_{OO}) is the sum of the input offset voltage (V_{IO}) and both input bias currents (I_{IB}) times the corresponding gains. The following schematic and formula can be used to calculate the output offset voltage:

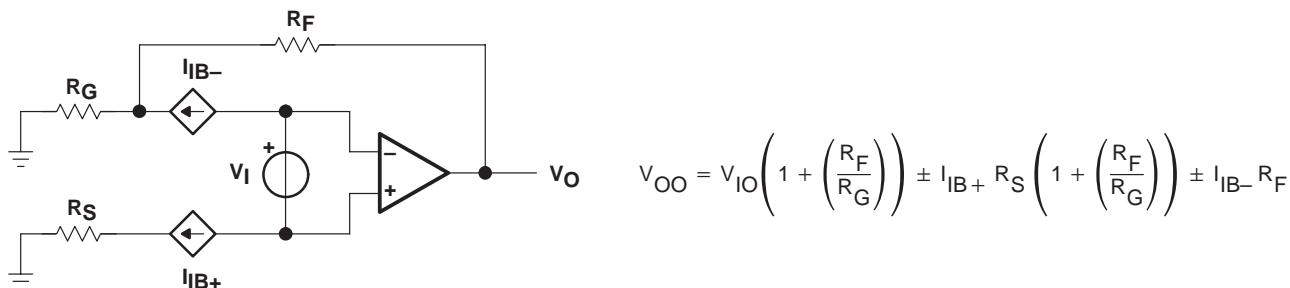

Figure 25. Output Offset Voltage Model

general configurations

When receiving low-level signals, limiting the bandwidth of the incoming signals into the system is often required. The simplest way to accomplish this is to place an RC filter at the noninverting terminal of the amplifier (see Figure 26).

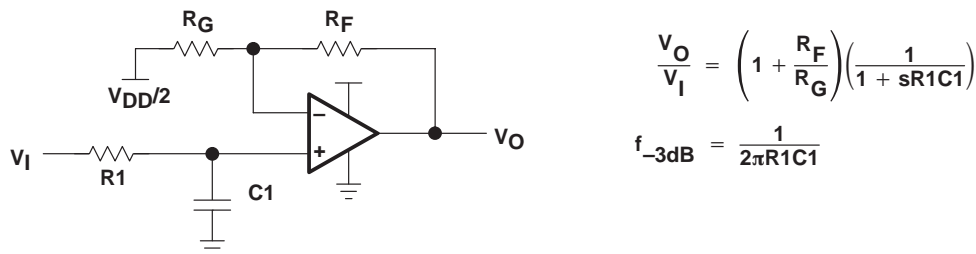

Figure 26. Single-Pole Low-Pass Filter

If even more attenuation is needed, a multiple pole filter is required. The Sallen-Key filter can be used for this task. For best results, the amplifier should have a bandwidth that is 8 to 10 times the filter frequency bandwidth. Failure to do this can result in phase shift of the amplifier.

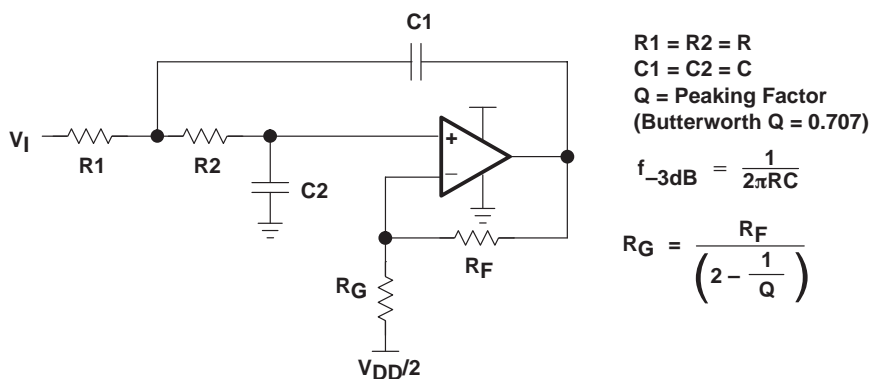

Figure 27. 2-Pole Low-Pass Sallen-Key Filter

APPLICATION INFORMATION

circuit layout considerations

To achieve the levels of high performance of the TLV27Lx, follow proper printed-circuit board design techniques. A general set of guidelines is given in the following.

- Ground planes—It is highly recommended that a ground plane be used on the board to provide all components with a low inductive ground connection. However, in the areas of the amplifier inputs and output, the ground plane can be removed to minimize the stray capacitance.
- Proper power supply decoupling—Use a 6.8- μ F tantalum capacitor in parallel with a 0.1- μ F ceramic capacitor on each supply terminal. It may be possible to share the tantalum among several amplifiers depending on the application, but a 0.1- μ F ceramic capacitor should always be used on the supply terminal of every amplifier. In addition, the 0.1- μ F capacitor should be placed as close as possible to the supply terminal. As this distance increases, the inductance in the connecting trace makes the capacitor less effective. The designer should strive for distances of less than 0.1 inches between the device power terminals and the ceramic capacitors.
- Sockets—Sockets can be used but are not recommended. The additional lead inductance in the socket pins will often lead to stability problems. Surface-mount packages soldered directly to the printed-circuit board is the best implementation.
- Short trace runs/compact part placements—Optimum high performance is achieved when stray series inductance has been minimized. To realize this, the circuit layout should be made as compact as possible, thereby minimizing the length of all trace runs. Particular attention should be paid to the inverting input of the amplifier. Its length should be kept as short as possible. This will help to minimize stray capacitance at the input of the amplifier.
- Surface-mount passive components—Using surface-mount passive components is recommended for high performance amplifier circuits for several reasons. First, because of the extremely low lead inductance of surface-mount components, the problem with stray series inductance is greatly reduced. Second, the small size of surface-mount components naturally leads to a more compact layout thereby minimizing both stray inductance and capacitance. If leaded components are used, it is recommended that the lead lengths be kept as short as possible.

APPLICATION INFORMATION

general power dissipation considerations

For a given θ_{JA} , the maximum power dissipation is shown in Figure 28 and is calculated by the following formula:

$$P_D = \left(\frac{T_{MAX} - T_A}{\theta_{JA}} \right)$$

Where:

- P_D = Maximum power dissipation of TLV27Lx IC (watts)
- T_{MAX} = Absolute maximum junction temperature (150°C)
- T_A = Free-ambient air temperature (°C)
- θ_{JA} = $\theta_{JC} + \theta_{CA}$
- θ_{JC} = Thermal coefficient from junction to case
- θ_{CA} = Thermal coefficient from case to ambient air (°C/W)

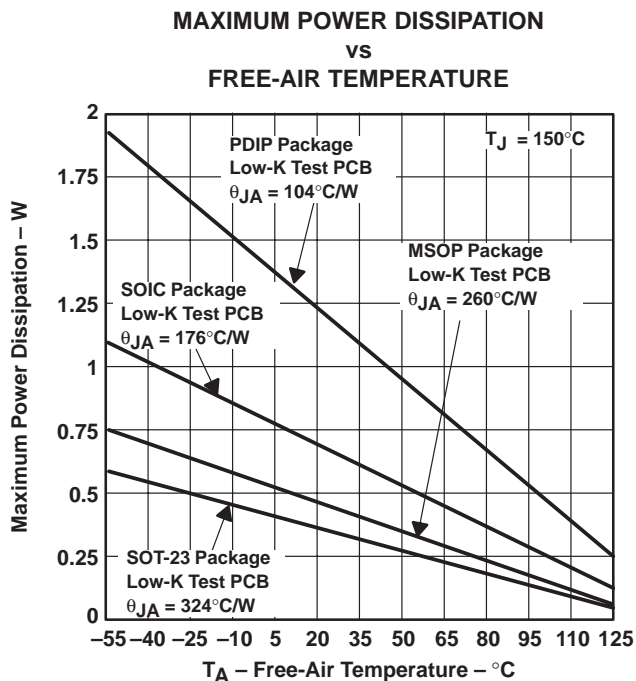

NOTE A: Results are with no air flow and using JEDEC Standard Low-K test PCB.

Figure 28. Maximum Power Dissipation vs Free-Air Temperature

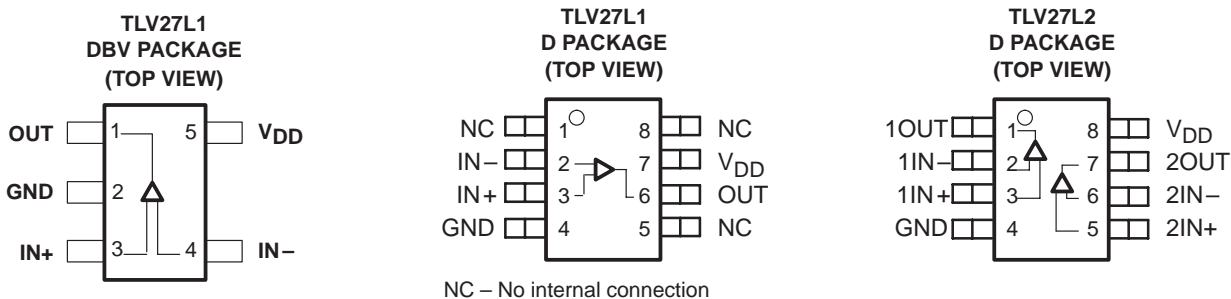

PACKAGING INFORMATION

Orderable Device	Status ⁽¹⁾	Package Type	Package Drawing	Pins	Package Qty	Eco Plan ⁽²⁾	Lead/Ball Finish	MSL Peak Temp ⁽³⁾
TLV27L1CD	ACTIVE	SOIC	D	8	75	Green (RoHS & no Sb/Br)	CU NIPDAU	Level-1-260C-UNLIM
TLV27L1CDBVR	ACTIVE	SOT-23	DBV	5	3000	Green (RoHS & no Sb/Br)	CU NIPDAU	Level-1-260C-UNLIM
TLV27L1CDBVRG4	ACTIVE	SOT-23	DBV	5	3000	Green (RoHS & no Sb/Br)	CU NIPDAU	Level-1-260C-UNLIM
TLV27L1CDBVT	ACTIVE	SOT-23	DBV	5	250	Green (RoHS & no Sb/Br)	CU NIPDAU	Level-1-260C-UNLIM
TLV27L1CDBVTG4	ACTIVE	SOT-23	DBV	5	250	Green (RoHS & no Sb/Br)	CU NIPDAU	Level-1-260C-UNLIM
TLV27L1CDG4	ACTIVE	SOIC	D	8	75	Green (RoHS & no Sb/Br)	CU NIPDAU	Level-1-260C-UNLIM
TLV27L1ID	ACTIVE	SOIC	D	8	75	Green (RoHS & no Sb/Br)	CU NIPDAU	Level-1-260C-UNLIM
TLV27L1IDBVR	ACTIVE	SOT-23	DBV	5	3000	Green (RoHS & no Sb/Br)	CU NIPDAU	Level-1-260C-UNLIM
TLV27L1IDBVRG4	ACTIVE	SOT-23	DBV	5	3000	Green (RoHS & no Sb/Br)	CU NIPDAU	Level-1-260C-UNLIM
TLV27L1IDBVT	ACTIVE	SOT-23	DBV	5	250	Green (RoHS & no Sb/Br)	CU NIPDAU	Level-1-260C-UNLIM
TLV27L1IDBVTG4	ACTIVE	SOT-23	DBV	5	250	Green (RoHS & no Sb/Br)	CU NIPDAU	Level-1-260C-UNLIM
TLV27L1IDG4	ACTIVE	SOIC	D	8	75	Green (RoHS & no Sb/Br)	CU NIPDAU	Level-1-260C-UNLIM
TLV27L1IDR	ACTIVE	SOIC	D	8	2500	Green (RoHS & no Sb/Br)	CU NIPDAU	Level-1-260C-UNLIM
TLV27L1IDRG4	ACTIVE	SOIC	D	8	2500	Green (RoHS & no Sb/Br)	CU NIPDAU	Level-1-260C-UNLIM
TLV27L2CDGK	ACTIVE	MSOP	DGK	8	80	Green (RoHS & no Sb/Br)	CU NIPDAU	Level-1-260C-UNLIM
TLV27L2CDGKG4	ACTIVE	MSOP	DGK	8	80	Green (RoHS & no Sb/Br)	CU NIPDAU	Level-1-260C-UNLIM
TLV27L2CDGKR	ACTIVE	MSOP	DGK	8	2500	Green (RoHS & no Sb/Br)	CU NIPDAU	Level-1-260C-UNLIM
TLV27L2CDGKRG4	ACTIVE	MSOP	DGK	8	2500	Green (RoHS & no Sb/Br)	CU NIPDAU	Level-1-260C-UNLIM
TLV27L2CDR	ACTIVE	SOIC	D	8	2500	Green (RoHS & no Sb/Br)	CU NIPDAU	Level-1-260C-UNLIM
TLV27L2CDRG4	ACTIVE	SOIC	D	8	2500	Green (RoHS & no Sb/Br)	CU NIPDAU	Level-1-260C-UNLIM
TLV27L2ID	ACTIVE	SOIC	D	8	75	Green (RoHS & no Sb/Br)	CU NIPDAU	Level-1-260C-UNLIM
TLV27L2IDG4	ACTIVE	SOIC	D	8	75	Green (RoHS & no Sb/Br)	CU NIPDAU	Level-1-260C-UNLIM
TLV27L2IDGK	ACTIVE	MSOP	DGK	8	80	Green (RoHS & no Sb/Br)	CU NIPDAU	Level-1-260C-UNLIM
TLV27L2IDGKG4	ACTIVE	MSOP	DGK	8	80	Green (RoHS & no Sb/Br)	CU NIPDAU	Level-1-260C-UNLIM
TLV27L2IDGKR	ACTIVE	MSOP	DGK	8	2500	Green (RoHS & no Sb/Br)	CU NIPDAU	Level-1-260C-UNLIM

Orderable Device	Status ⁽¹⁾	Package Type	Package Drawing	Pins	Package Qty	Eco Plan ⁽²⁾	Lead/Ball Finish	MSL Peak Temp ⁽³⁾
TLV27L2IDGKRG4	ACTIVE	MSOP	DGK	8	2500	Green (RoHS & no Sb/Br)	CU NIPDAU	Level-1-260C-UNLIM
TLV27L2IDR	ACTIVE	SOIC	D	8	2500	Green (RoHS & no Sb/Br)	CU NIPDAU	Level-1-260C-UNLIM
TLV27L2IDRG4	ACTIVE	SOIC	D	8	2500	Green (RoHS & no Sb/Br)	CU NIPDAU	Level-1-260C-UNLIM

⁽¹⁾ The marketing status values are defined as follows:

ACTIVE: Product device recommended for new designs.

LIFEBUY: TI has announced that the device will be discontinued, and a lifetime-buy period is in effect.

NRND: Not recommended for new designs. Device is in production to support existing customers, but TI does not recommend using this part in a new design.

PREVIEW: Device has been announced but is not in production. Samples may or may not be available.

OBSOLETE: TI has discontinued the production of the device.

⁽²⁾ Eco Plan - The planned eco-friendly classification: Pb-Free (RoHS), Pb-Free (RoHS Exempt), or Green (RoHS & no Sb/Br) - please check <http://www.ti.com/productcontent> for the latest availability information and additional product content details.

TBD: The Pb-Free/Green conversion plan has not been defined.

Pb-Free (RoHS): TI's terms "Lead-Free" or "Pb-Free" mean semiconductor products that are compatible with the current RoHS requirements for all 6 substances, including the requirement that lead not exceed 0.1% by weight in homogeneous materials. Where designed to be soldered at high temperatures, TI Pb-Free products are suitable for use in specified lead-free processes.

Pb-Free (RoHS Exempt): This component has a RoHS exemption for either 1) lead-based flip-chip solder bumps used between the die and package, or 2) lead-based die adhesive used between the die and leadframe. The component is otherwise considered Pb-Free (RoHS compatible) as defined above.

Green (RoHS & no Sb/Br): TI defines "Green" to mean Pb-Free (RoHS compatible), and free of Bromine (Br) and Antimony (Sb) based flame retardants (Br or Sb do not exceed 0.1% by weight in homogeneous material)

⁽³⁾ MSL, Peak Temp. -- The Moisture Sensitivity Level rating according to the JEDEC industry standard classifications, and peak solder temperature.

Important Information and Disclaimer:The information provided on this page represents TI's knowledge and belief as of the date that it is provided. TI bases its knowledge and belief on information provided by third parties, and makes no representation or warranty as to the accuracy of such information. Efforts are underway to better integrate information from third parties. TI has taken and continues to take reasonable steps to provide representative and accurate information but may not have conducted destructive testing or chemical analysis on incoming materials and chemicals. TI and TI suppliers consider certain information to be proprietary, and thus CAS numbers and other limited information may not be available for release.

In no event shall TI's liability arising out of such information exceed the total purchase price of the TI part(s) at issue in this document sold by TI to Customer on an annual basis.

TAPE AND REEL INFORMATION



QUADRANT ASSIGNMENTS FOR PIN 1 ORIENTATION IN TAPE



*All dimensions are nominal

Device	Package Type	Package Drawing	Pins	SPQ	Reel Diameter (mm)	Reel Width W1 (mm)	A0 (mm)	B0 (mm)	K0 (mm)	P1 (mm)	W (mm)	Pin1 Quadrant
TLV27L1CDBVR	SOT-23	DBV	5	3000	180.0	9.0	3.15	3.2	1.4	4.0	8.0	Q3
TLV27L1CDBVT	SOT-23	DBV	5	250	180.0	9.0	3.15	3.2	1.4	4.0	8.0	Q3
TLV27L1IDBVR	SOT-23	DBV	5	3000	180.0	9.0	3.15	3.2	1.4	4.0	8.0	Q3
TLV27L1IDBVT	SOT-23	DBV	5	250	180.0	9.0	3.15	3.2	1.4	4.0	8.0	Q3
TLV27L1IDR	SOIC	D	8	2500	330.0	12.4	6.4	5.2	2.1	8.0	12.0	Q1
TLV27L2CDGKR	MSOP	DGK	8	2500	330.0	12.4	5.3	3.4	1.4	8.0	12.0	Q1
TLV27L2CDR	SOIC	D	8	2500	330.0	12.4	6.4	5.2	2.1	8.0	12.0	Q1
TLV27L2IDGKR	MSOP	DGK	8	2500	330.0	12.4	5.3	3.4	1.4	8.0	12.0	Q1
TLV27L2IDR	SOIC	D	8	2500	330.0	12.4	6.4	5.2	2.1	8.0	12.0	Q1

TAPE AND REEL BOX DIMENSIONS



*All dimensions are nominal

Device	Package Type	Package Drawing	Pins	SPQ	Length (mm)	Width (mm)	Height (mm)
TLV27L1CDBVR	SOT-23	DBV	5	3000	182.0	182.0	20.0
TLV27L1CDBVT	SOT-23	DBV	5	250	182.0	182.0	20.0
TLV27L1IDBVR	SOT-23	DBV	5	3000	182.0	182.0	20.0
TLV27L1IDBVT	SOT-23	DBV	5	250	182.0	182.0	20.0
TLV27L1IDR	SOIC	D	8	2500	340.5	338.1	20.6
TLV27L2CDGKR	MSOP	DGK	8	2500	358.0	335.0	35.0
TLV27L2CDDR	SOIC	D	8	2500	340.5	338.1	20.6
TLV27L2IDGKR	MSOP	DGK	8	2500	358.0	335.0	35.0
TLV27L2IDR	SOIC	D	8	2500	340.5	338.1	20.6

DBV (R-PDSO-G5)

PLASTIC SMALL-OUTLINE PACKAGE



- NOTES:
- A. All linear dimensions are in millimeters.
 - B. This drawing is subject to change without notice.
 - C. Body dimensions do not include mold flash or protrusion. Mold flash and protrusion shall not exceed 0.15 per side.
 - D. Falls within JEDEC MO-178 Variation AA.

DGK (S-PDSO-G8)

PLASTIC SMALL-OUTLINE PACKAGE



- NOTES:
- A. All linear dimensions are in millimeters.
 - B. This drawing is subject to change without notice.
 - C. Body length does not include mold flash, protrusions, or gate burrs. Mold flash, protrusions, or gate burrs shall not exceed 0.15 per end.
 - D. Body width does not include interlead flash. Interlead flash shall not exceed 0.50 per side.
 - E. Falls within JEDEC MO-187 variation AA, except interlead flash.

D (R-PDSO-G8)

PLASTIC SMALL-OUTLINE PACKAGE



- NOTES:
- A. All linear dimensions are in inches (millimeters).
 - B. This drawing is subject to change without notice.
 - C. Body length does not include mold flash, protrusions, or gate burrs. Mold flash, protrusions, or gate burrs shall not exceed .006 (0,15) per end.
 - D. Body width does not include interlead flash. Interlead flash shall not exceed .017 (0,43) per side.
 - E. Reference JEDEC MS-012 variation AA.

IMPORTANT NOTICE

Texas Instruments Incorporated and its subsidiaries (TI) reserve the right to make corrections, modifications, enhancements, improvements, and other changes to its products and services at any time and to discontinue any product or service without notice. Customers should obtain the latest relevant information before placing orders and should verify that such information is current and complete. All products are sold subject to TI's terms and conditions of sale supplied at the time of order acknowledgment.

TI warrants performance of its hardware products to the specifications applicable at the time of sale in accordance with TI's standard warranty. Testing and other quality control techniques are used to the extent TI deems necessary to support this warranty. Except where mandated by government requirements, testing of all parameters of each product is not necessarily performed.

TI assumes no liability for applications assistance or customer product design. Customers are responsible for their products and applications using TI components. To minimize the risks associated with customer products and applications, customers should provide adequate design and operating safeguards.

TI does not warrant or represent that any license, either express or implied, is granted under any TI patent right, copyright, mask work right, or other TI intellectual property right relating to any combination, machine, or process in which TI products or services are used. Information published by TI regarding third-party products or services does not constitute a license from TI to use such products or services or a warranty or endorsement thereof. Use of such information may require a license from a third party under the patents or other intellectual property of the third party, or a license from TI under the patents or other intellectual property of TI.

Reproduction of TI information in TI data books or data sheets is permissible only if reproduction is without alteration and is accompanied by all associated warranties, conditions, limitations, and notices. Reproduction of this information with alteration is an unfair and deceptive business practice. TI is not responsible or liable for such altered documentation. Information of third parties may be subject to additional restrictions.

Resale of TI products or services with statements different from or beyond the parameters stated by TI for that product or service voids all express and any implied warranties for the associated TI product or service and is an unfair and deceptive business practice. TI is not responsible or liable for any such statements.

TI products are not authorized for use in safety-critical applications (such as life support) where a failure of the TI product would reasonably be expected to cause severe personal injury or death, unless officers of the parties have executed an agreement specifically governing such use. Buyers represent that they have all necessary expertise in the safety and regulatory ramifications of their applications, and acknowledge and agree that they are solely responsible for all legal, regulatory and safety-related requirements concerning their products and any use of TI products in such safety-critical applications, notwithstanding any applications-related information or support that may be provided by TI. Further, Buyers must fully indemnify TI and its representatives against any damages arising out of the use of TI products in such safety-critical applications.

TI products are neither designed nor intended for use in military/aerospace applications or environments unless the TI products are specifically designated by TI as military-grade or "enhanced plastic." Only products designated by TI as military-grade meet military specifications. Buyers acknowledge and agree that any such use of TI products which TI has not designated as military-grade is solely at the Buyer's risk, and that they are solely responsible for compliance with all legal and regulatory requirements in connection with such use.

TI products are neither designed nor intended for use in automotive applications or environments unless the specific TI products are designated by TI as compliant with ISO/TS 16949 requirements. Buyers acknowledge and agree that, if they use any non-designated products in automotive applications, TI will not be responsible for any failure to meet such requirements.

Following are URLs where you can obtain information on other Texas Instruments products and application solutions:

Products

Amplifiers	amplifier.ti.com
Data Converters	dataconverter.ti.com
DSP	dsp.ti.com
Clocks and Timers	www.ti.com/clocks
Interface	interface.ti.com
Logic	logic.ti.com
Power Mgmt	power.ti.com
Microcontrollers	microcontroller.ti.com
RFID	www.ti-rfid.com
RF/IF and ZigBee® Solutions	www.ti.com/lprf

Applications

Audio	www.ti.com/audio
Automotive	www.ti.com/automotive
Broadband	www.ti.com/broadband
Digital Control	www.ti.com/digitalcontrol
Medical	www.ti.com/medical
Military	www.ti.com/military
Optical Networking	www.ti.com/opticalnetwork
Security	www.ti.com/security
Telephony	www.ti.com/telephony
Video & Imaging	www.ti.com/video
Wireless	www.ti.com/wireless

Mailing Address: Texas Instruments, Post Office Box 655303, Dallas, Texas 75265
Copyright © 2008, Texas Instruments Incorporated